

Whitecap

Units	INCHES	View	
P/N	S-4053		20170731

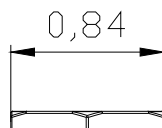
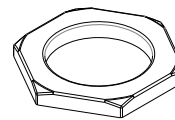
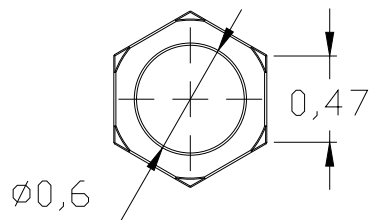
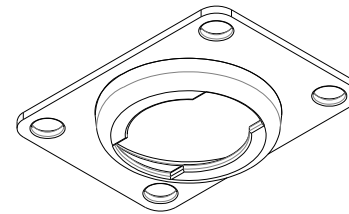
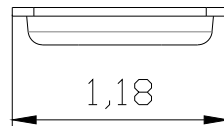
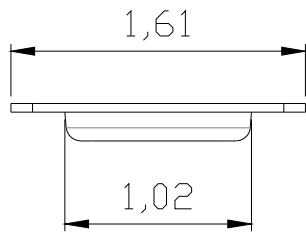
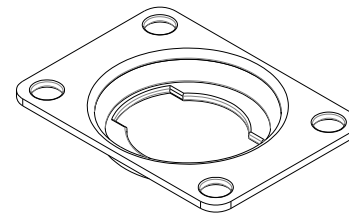
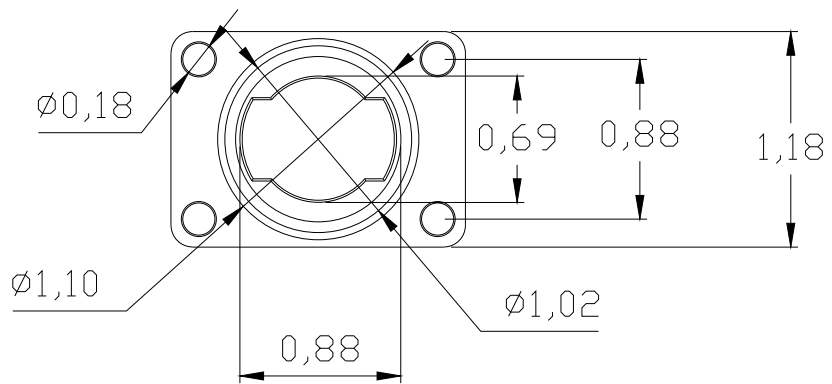

Whitecap

Units	INCHES	View	
P/N	S-4053-1		20170731