

SECTION A-A

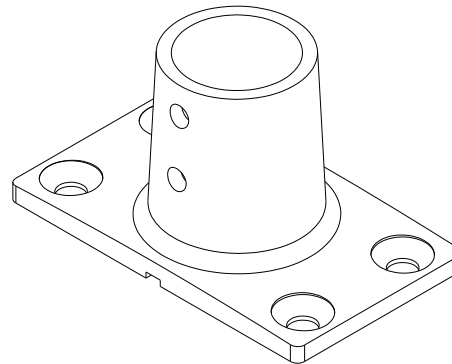

Whitecap			
Units	INCHES	View	
P/N	6141		20161120