

SECTION A-A

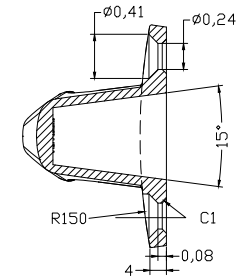

SECTION B-B

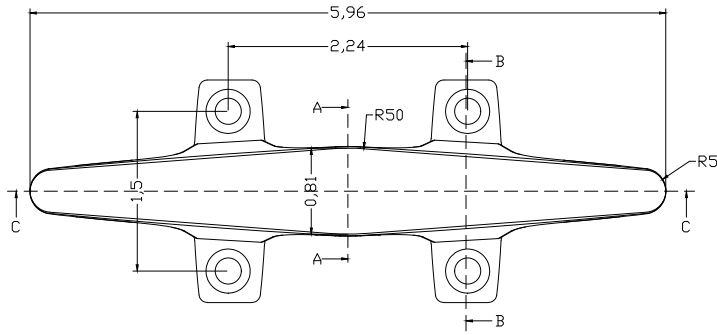
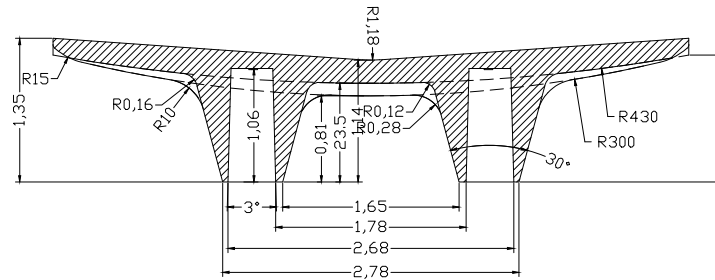

SECTION C-C

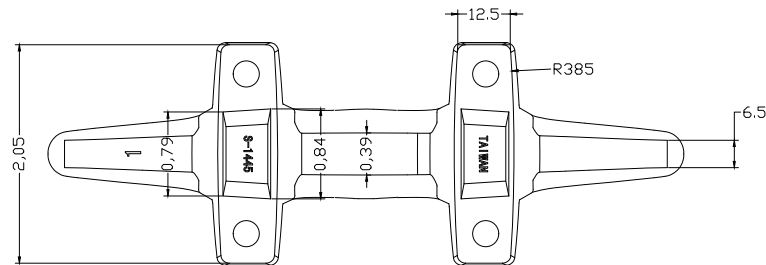
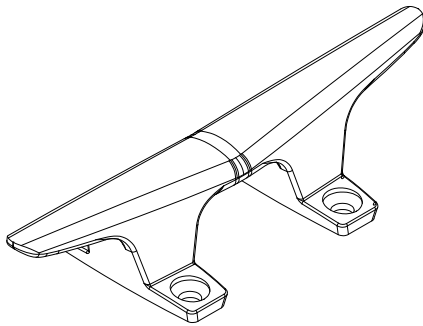

Whitecap			
Units	INCHES	View	
P/N	S-1445		20160927